

EN

UNIVERSAL SNOW BLADE MOUNTING PAD
INSTALLATION MANUAL

DE

MONTAGEANLEITUNG FÜR
UNIVERSAL-SCHNEESCHILD-MONTAGEPADS



For: CFMoto ZForce 800 (2013-2022)

2444.0084.1

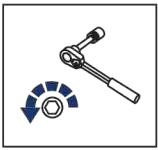

EN Regular fasteners
DE Originale montageile

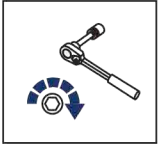

EN Regular fasteners
DE Originale montageile

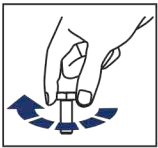

EN Screw a several turns
DE Für wenigen Umdrehungen befestigen

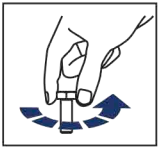

EN Loosen bolts
DE Bolzen lockern

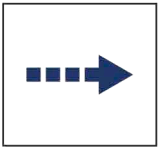

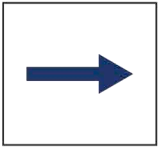

EN Movement Arrow
DE Bewegungsrichtung



EN Location/Position Arrow
DE Anordnung/Positionsrichtung





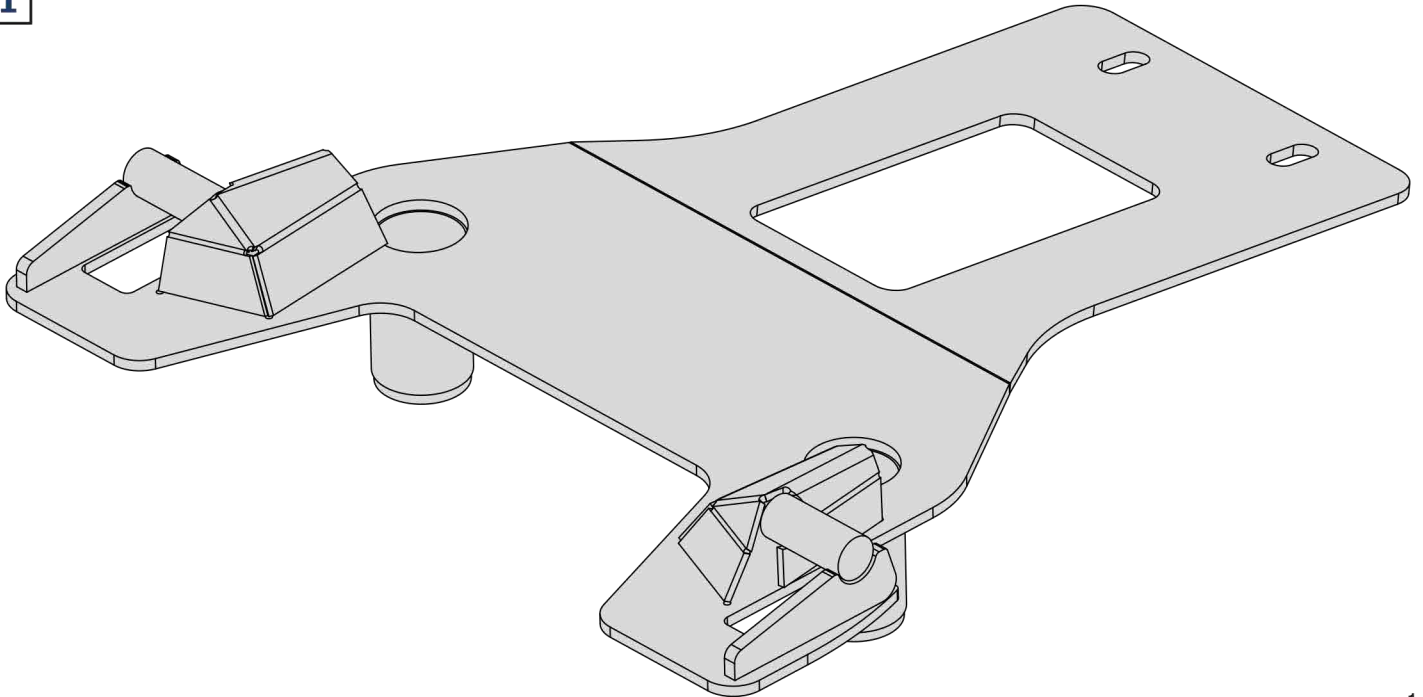

EN Screw Arrow
DE Drehungsrichtung

	EN Ratchet DE Ratsche		S - 13		S - 17
---	--------------------------	---	--------	--	--------

1

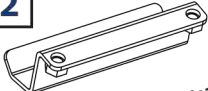
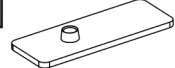
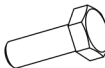

x1

2		3		4		5		6		7	
	x1	M10x105/35	x2	M8x35	x2	M10x35	x2	ø8	x2	ø10	x2

