

EN REAR BUMPER KIT INSTALLATION MANUAL

DE MONTAGEEINLEITUNG FÜR STOBFÄNGER-KIT

RU ИНСТРУКЦИЯ ПО УСТАНОВКЕ ЗАДНЕГО БАМПЕРА



For: CForce UForce 1000 EPS (2019-)

2444.6896.1



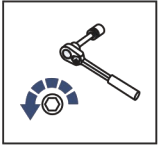

EN Regular fasteners
DE Originale montageteile
RU Штатный крепеж

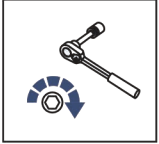

EN Regular fasteners
DE Originale montageteile
RU Штатный крепеж

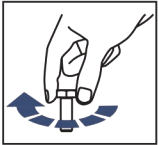

EN Screw a several turns
DE Für wenigen Umdrehungen befestigen
RU Вкрутить на несколько оборотов

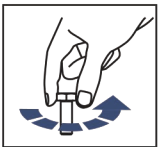

EN Loosen bolts
DE Bolzen lockern
RU Выкрутить на несколько оборотов

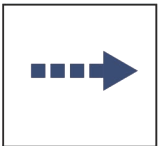

EN Movement Arrow
DE Bewegungsrichtung
RU Движение

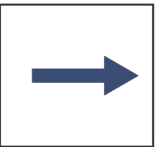





EN Location/Position Arrow
DE Anordnung/Positionsrichtung
RU Расположение

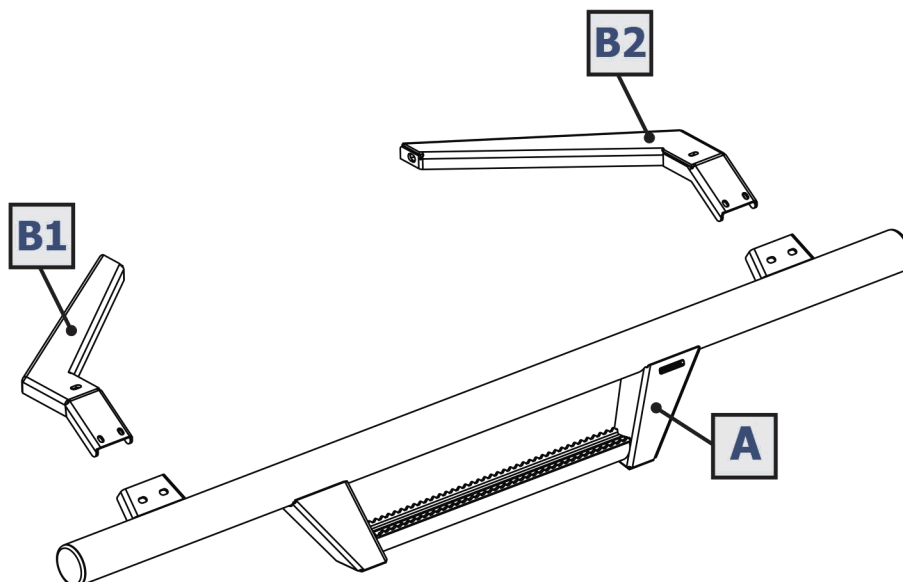
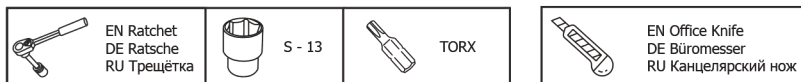

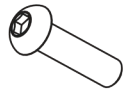
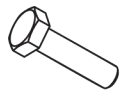
EN Screw Arrow
DE Drehungsrichtung
RU Поворот



1		2		3		4		5	
M6x20	x4	M8x20	x2	Ø6	x8	Ø8	x2	M6	x4

When mount the rear bumper 2444.6896.1 on the UTV with installed tow hitch receiver the opening of the bed will be reduced on about 1.5 inches.

